

COMPETITIVE ADVANTAGES

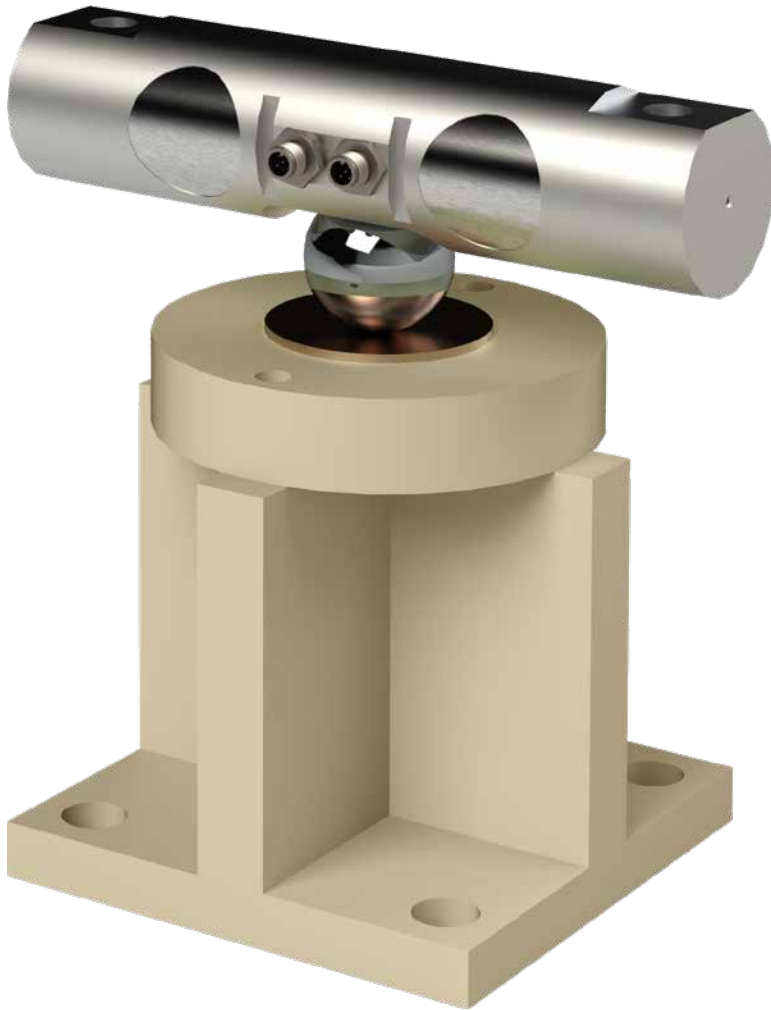

SMARTCELL®

DIGITAL LOAD CELLS



SMARTCELL® DIGITAL LOAD CELLS

Cardinal Scale's SmartCell® stainless steel digital load cells are the optimal solution in advanced load cell technology. Each IP69K-rated waterproof load cell is completely encapsulated and filled with a potting compound that fills all internal voids and prevents any potential for moisture entering the load cell and causing premature failure. The SmartCell's proven technology is internally factory calibrated at 10 points to achieve linear output. Messy, time-consuming wiring is no longer necessary – cables connect to the cell through metal braided rodent-proof cables. Load cells are daisy-chain linked directly to one another, yielding a more convenient, user-friendly system.

SmartCell® digital technology eliminates the need for a junction box and time-consuming wiring termination work. In fact, for a standard 70-ft-long vehicle scale, 92 wiring terminations and 14 jumper settings are completely eliminated, and sense leads are also no longer required since variations in system voltage will not impact the load cell. Painstakingly-long troubleshooting can be greatly reduced since most errors can be detected via the built-in diagnostic system, and load cell calibration is much simpler and easier.



FRICTIONLESS CENTERING SYSTEM

AXIS® FRICTIONLESS CENTERING SYSTEM

Cardinal Scale's axis® Frictionless Centering System is the next generation frontier for load-centering technology. The focal point of this technology is gravity-driven dynamic centering. Gone are the bumper bolts, flexures, and check rods used to restrict movement in earlier models. Cardinal Scale's unique, durable passive checking systems utilize gravity to restrain deck movement and vibration; in fact, the heavier the load is, the better. Since the system is constantly seeking its stable equilibrium point, it will absorb movements from the truck moving on the weighbridge and bring the weighbridge to rest more quickly and smoothly.

The load cell and components have been moved above the bottom of the deck, eliminating build-up failures due to corrosion, sediment, and filth. The wire tray above the cell houses 15 to 20 feet of wire comfortably. The load cell and integral wiring are now in a clean and simple compartment where they can be easily accessed in close proximity.

TABLE OF CONTENTS

PAGE

axis® Load Cell Stands and SmartCell® Digital Load Cells	1
ARMOR® Weighbridge Advantages – FEA Analysis Comparisons	2
Advantages of Digital Load Cells	10
iSite Remote Diagnostics Monitoring	11
NEST All-in-One Scale Diagnostic Toolkit	13
Tipping the Scales	15
Digital Load Cell Cable Chart	18



ARMOR® Weighbridge Advantages

TRUCK SCALE ENGINEERING FEA ANALYSIS COMPARISON

Cardinal Scale's engineering and management team extensively studied every truck scale on the market when developing the ARMOR® truck scale weighbridge. The design team researched key weaknesses in competitor's truck scales that led to breakages and structural integrity issues over the lifespan of the scale and looked for ways to improve upon every facet in a truck scale design.

The impressive results are shown in the ARMOR® truck scale weighbridge. The following FEA analysis renderings will demonstrate important areas where Cardinal Scale's ARMOR® weighbridge is superior to every other truck scale on the market due to vastly improved design elements and high-end construction techniques employed during manufacturing.

HEAD DESIGN

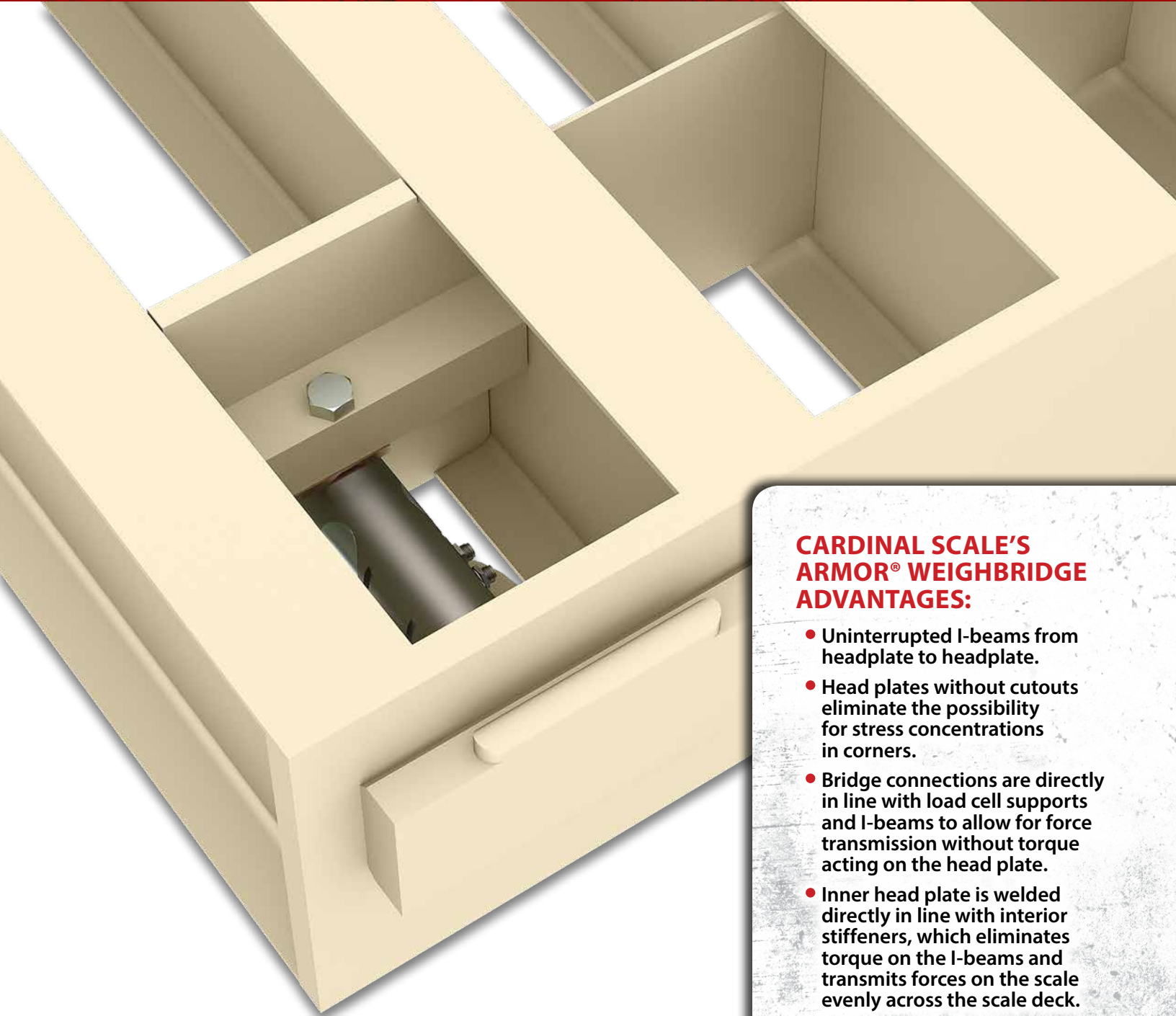

CARDINAL SCALE'S ARMOR® WEIGHBRIDGE ADVANTAGES:

- Uninterrupted I-beams from headplate to headplate.
- Head plates without cutouts eliminate the possibility for stress concentrations in corners.
- Bridge connections are directly in line with load cell supports and I-beams to allow for force transmission without torque acting on the head plate.
- Inner head plate is welded directly in line with interior stiffeners, which eliminates torque on the I-beams and transmits forces on the scale evenly across the scale deck.

LOAD CELL FORCE TRANSMISSION

CARDINAL SCALE'S ARMOR® WEIGHBRIDGE ADVANTAGES:

- The weighbridge connecting support block is welded to the one-inch-thick endplate and is in direct line with the I-beams and load cell support blocks which decreases torsion and stress points.
- The endplate has no cuts in it, so no stress concentrations are created.

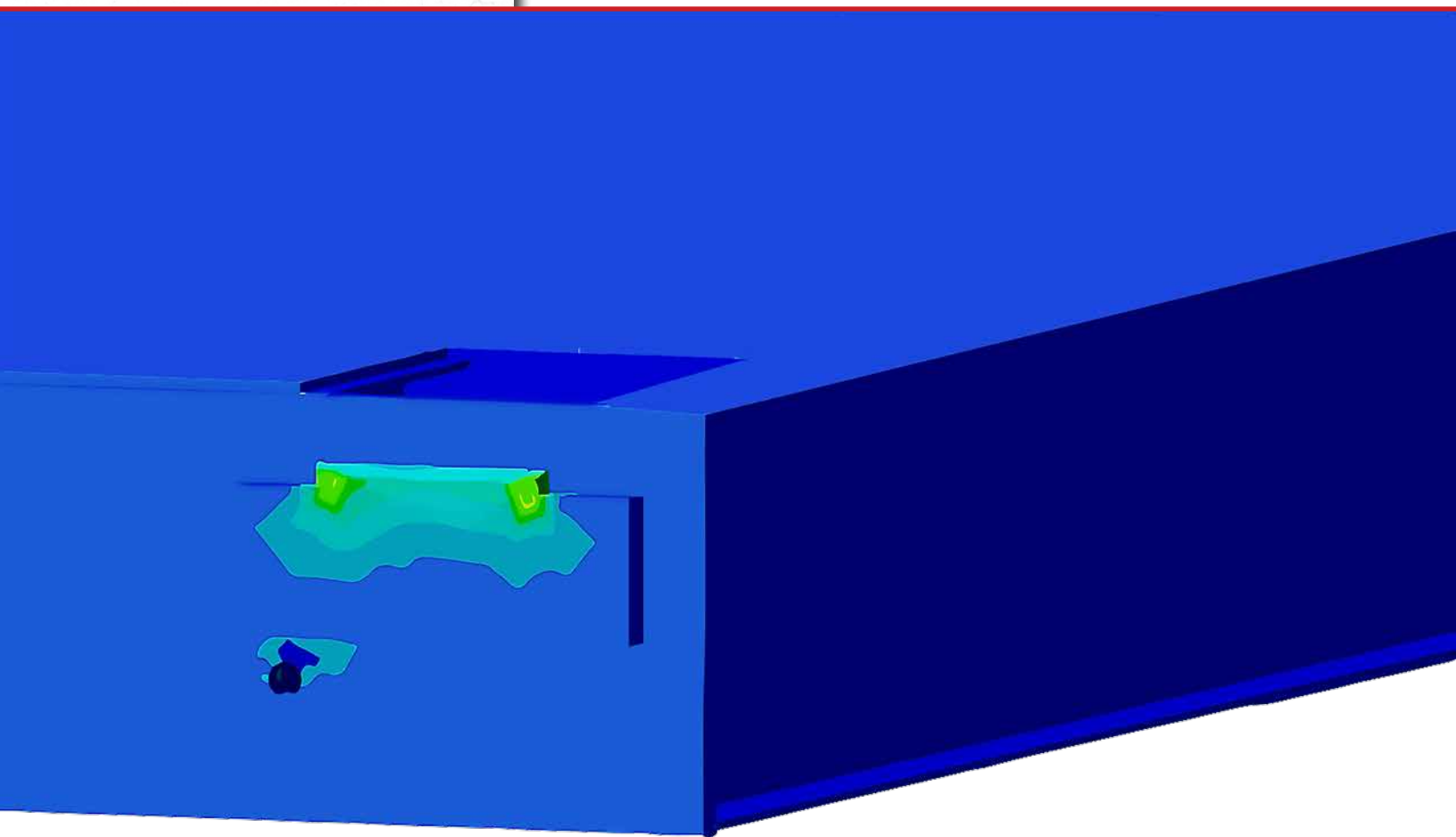
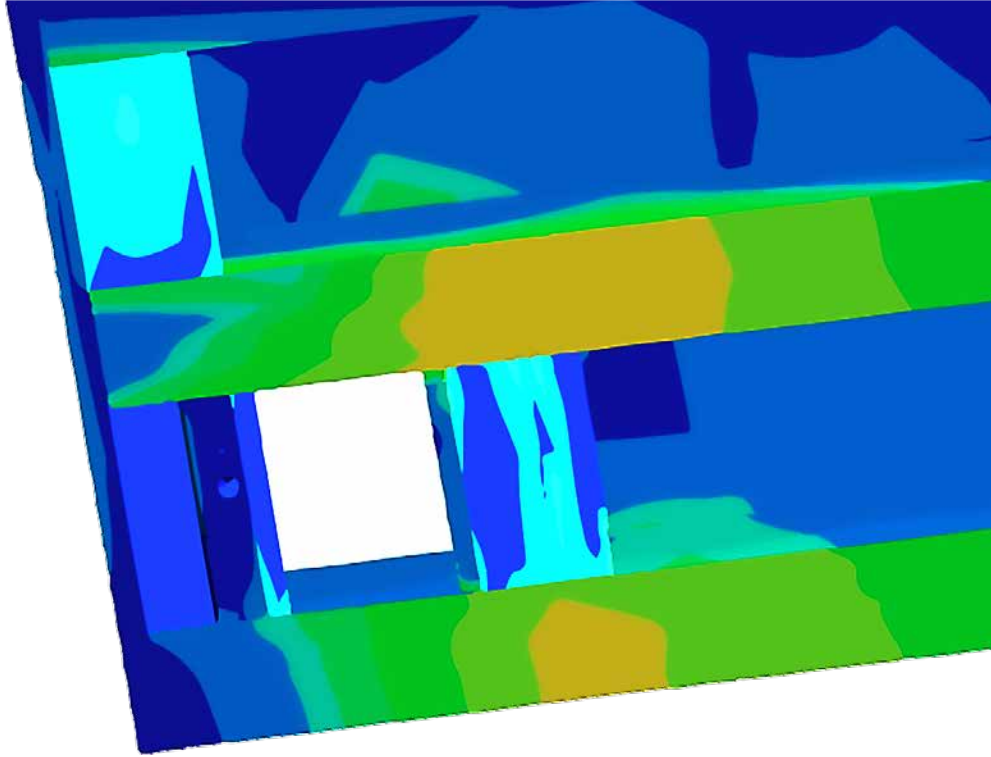

LOAD CELL FORCE TRANSMISSION

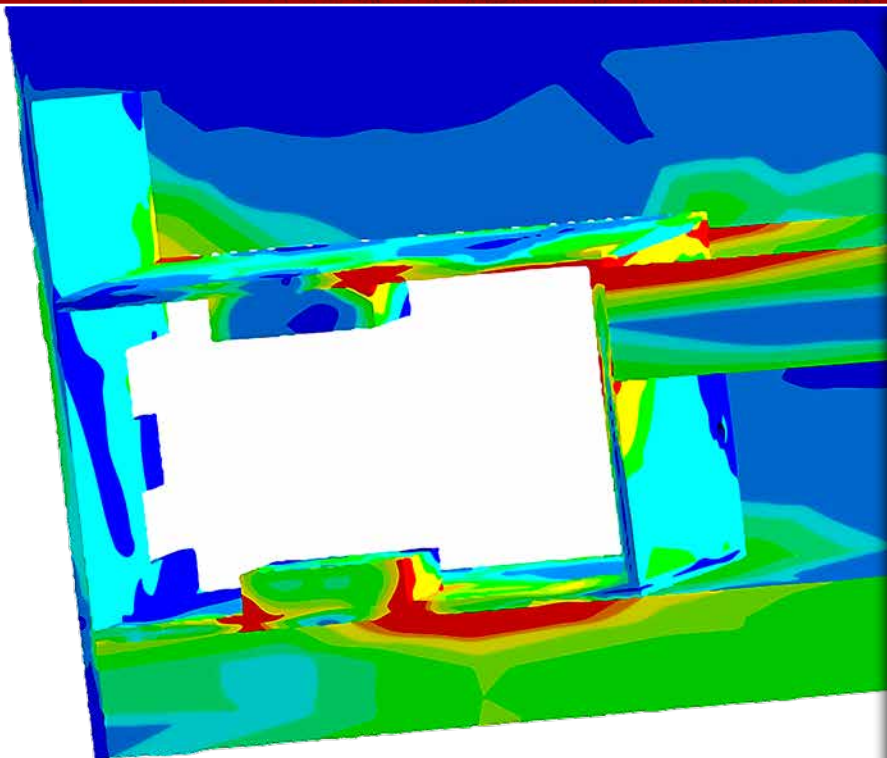

COMPETITOR DISADVANTAGES:

- Support block is welded onto the endplate with large cutouts causing weakening of the endplate and stress concentrations in the sharp corners of the cutout and high stress areas under the cut outs.
- Load cell support blocks are not inline with the bridge connector block, causing torsion and shear forces in the head plate.
- Cantilevered load cell support blocks cause torsion and shear forces in the head plate.
- Support block design that needs to be bolted together during installation.

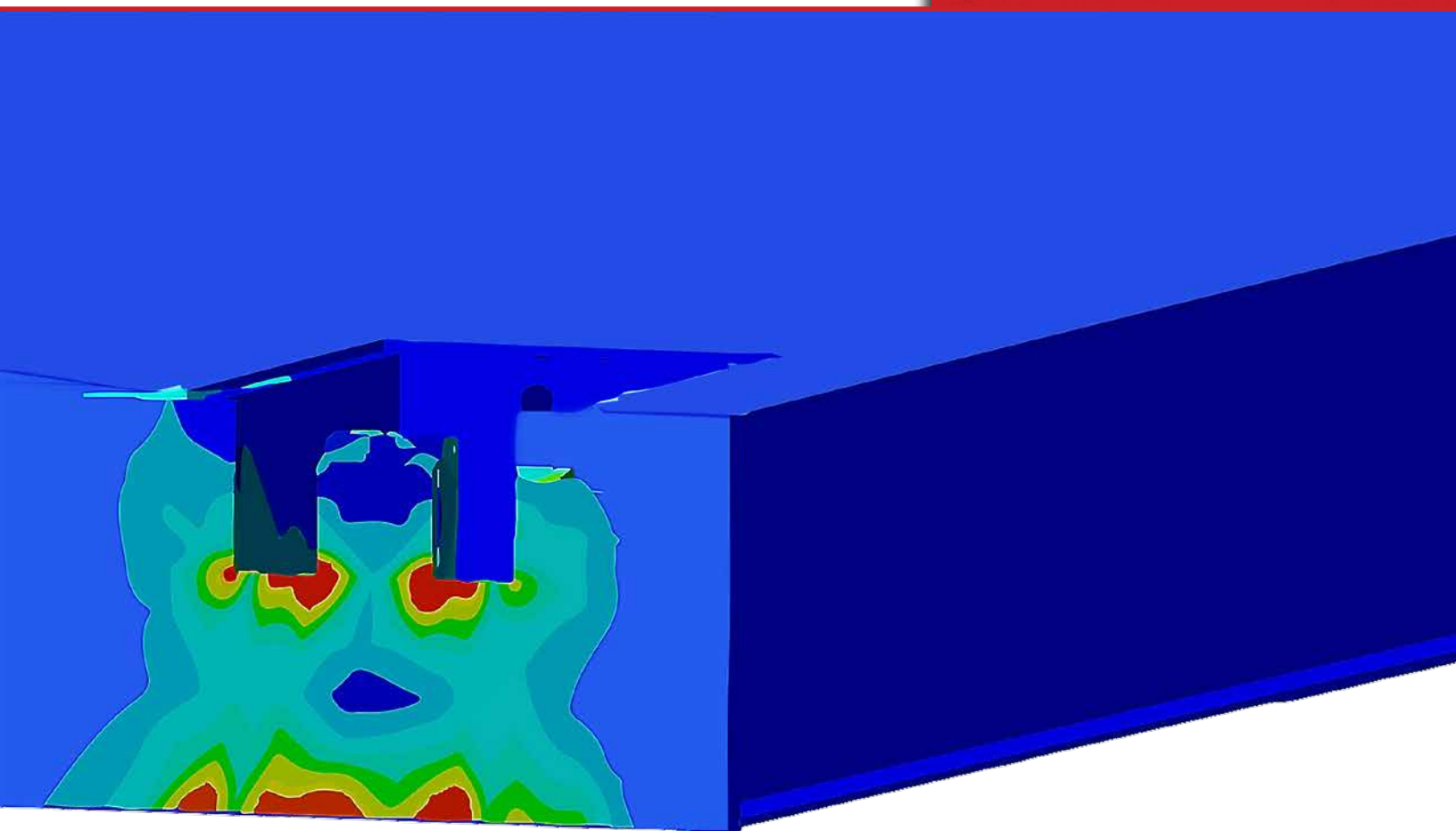

HOOK-ON FORCE TRANSMISSION (NON LOAD CELL SIDE)

CARDINAL SCALE'S ARMOR® WEIGHBRIDGE ADVANTAGES:

- Receiver cup welded in line with I-beams.
- No torsional force generated as the load is transferred from the I-beams, through the endplate, and to the receiver cup.

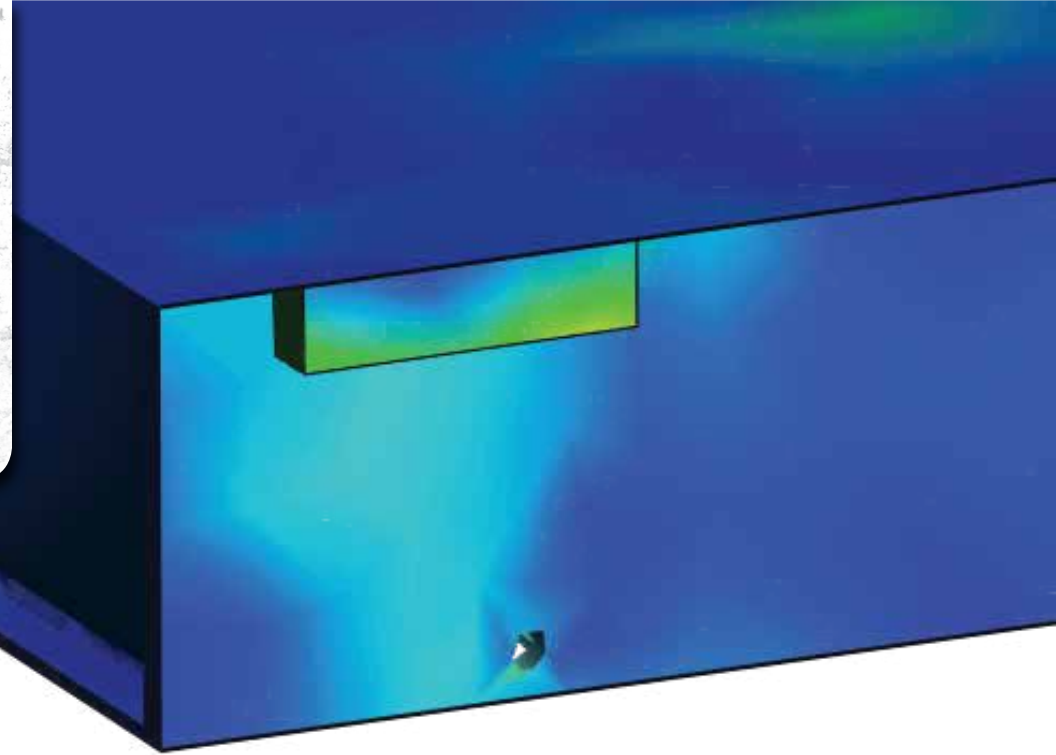

COMPETITOR DISADVANTAGES:

- Cantilevered pin design causes tension and torsional forces on head plate.
- Top of pin support on cantilever is subject to breaking due to fatigue.

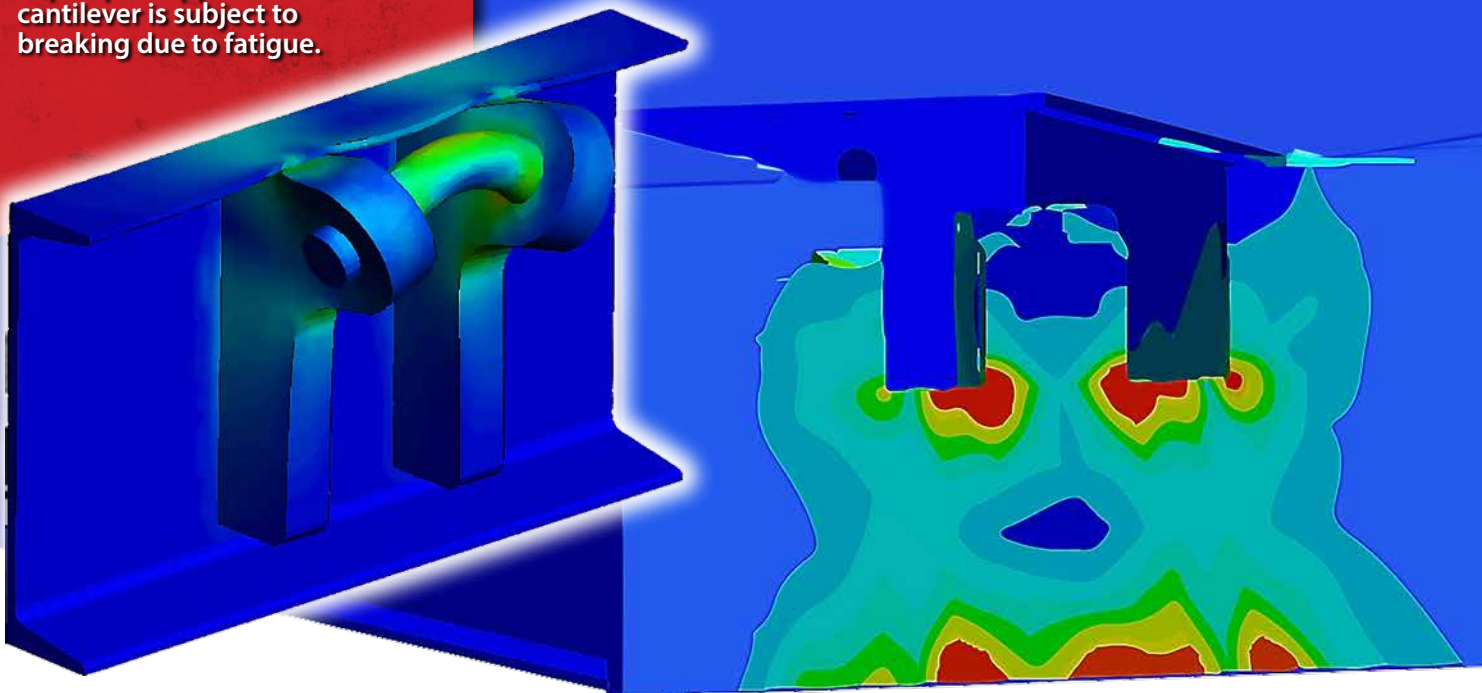

HOOK-ON FORCE TRANSMISSION (NON LOAD CELL SIDE)

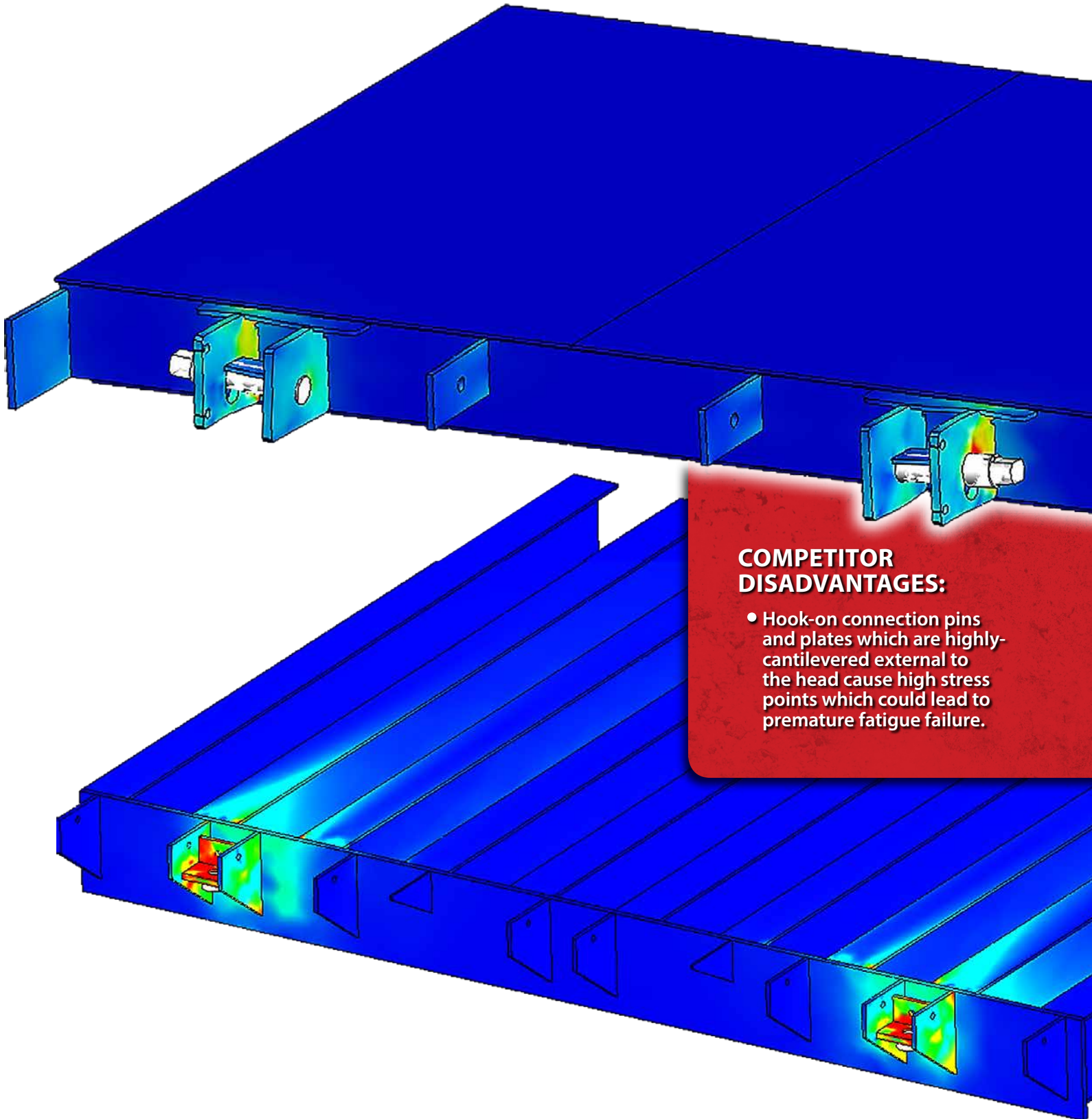

COMPETITOR DISADVANTAGES:

- Hook-on connection pins and plates which are highly-cantilevered external to the head cause high stress points which could lead to premature fatigue failure.

BRIDGE DESIGN

CARDINAL SCALE'S ARMOR® WEIGHBRIDGE ADVANTAGES:

- 12-inch I-beams with 4 rows of stiffeners provide low material stress levels and significantly reduced deflection and much longer weighbridge lifespan.

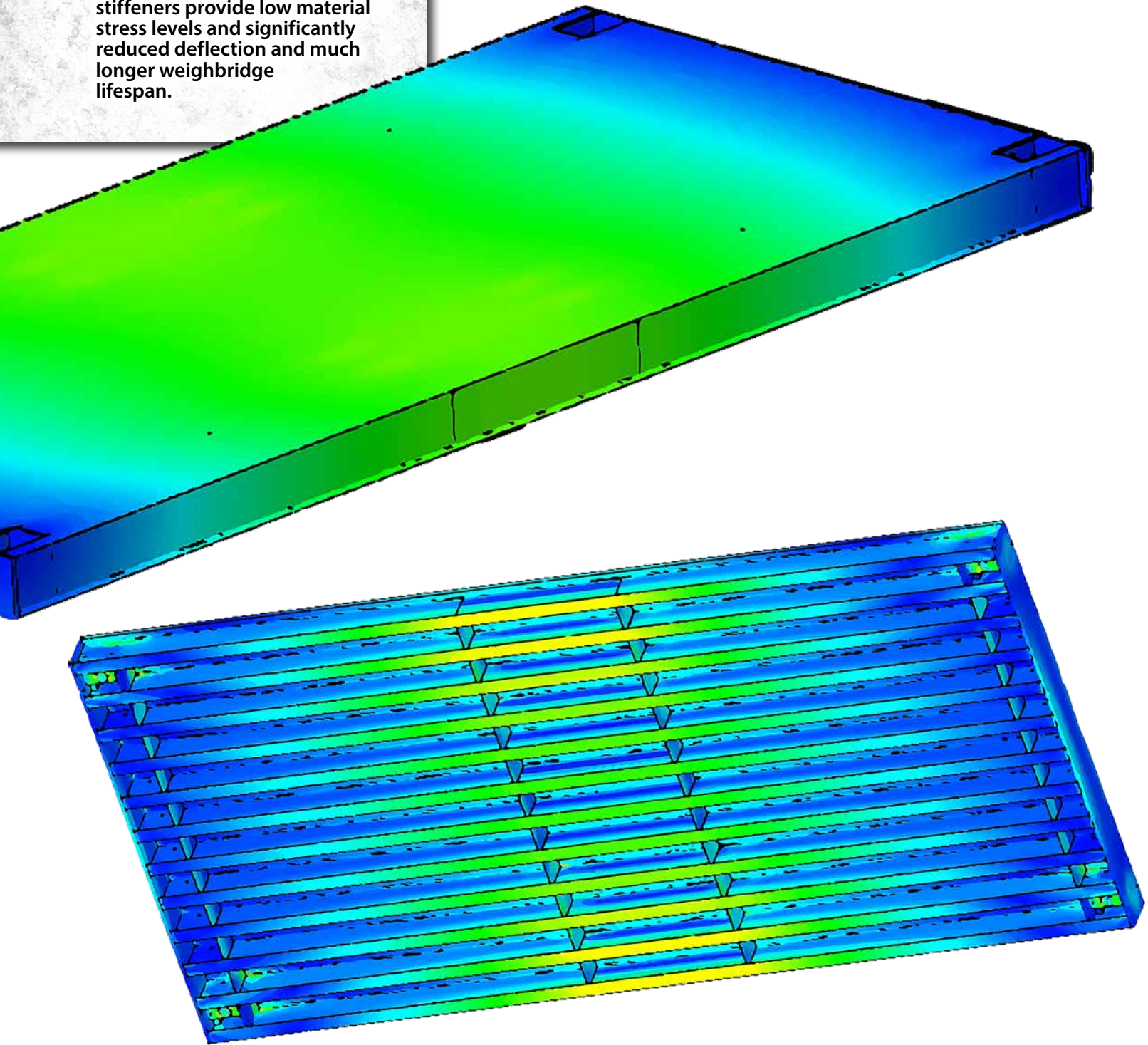

BRIDGE DESIGN

COMPETITOR DISADVANTAGES:

- 10-inch I-beams cause high stress concentrations and significant deflection, which leads to shorter service life.

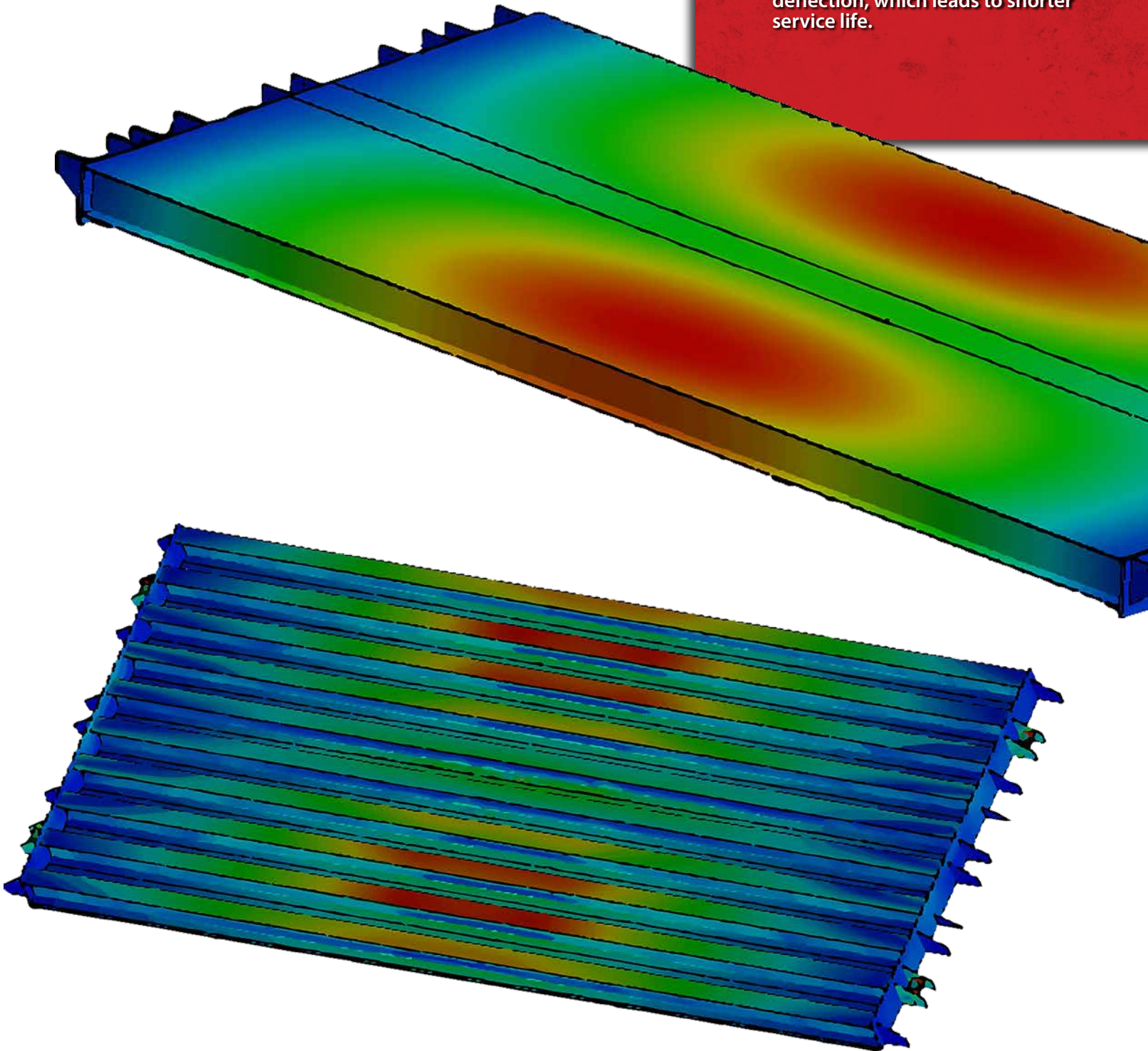

AIRFLOW

CARDINAL SCALE'S ARMOR® WEIGHBRIDGE ADVANTAGES:

- Wide open bottom throughout the weighbridge prevents moisture build-up which leads to corrosion.

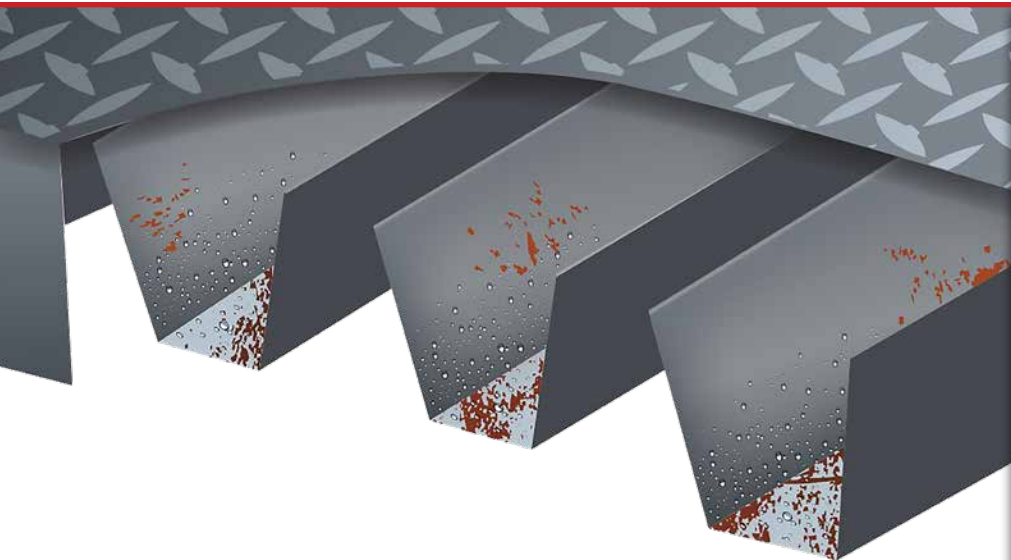
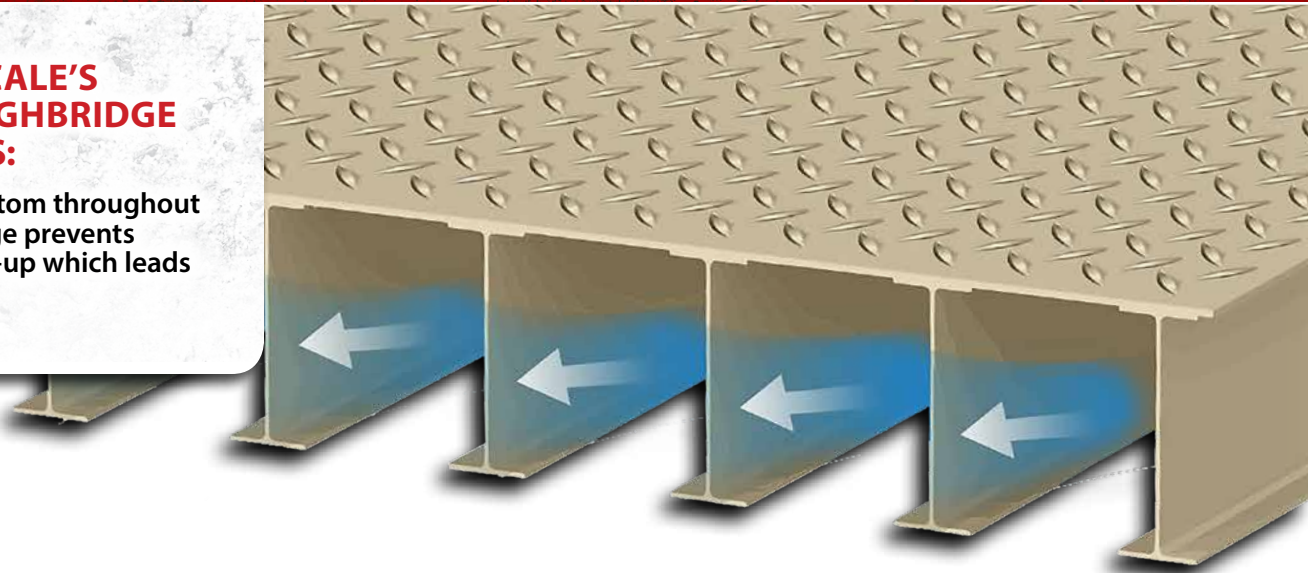

COMPETITOR DISADVANTAGES:

- Orthotropic design traps condensation which promotes corrosion.
- Improperly-executed weld start and stops and poor weld preparation can cause moisture to penetrate into the orthotropic structure and create water accumulation and corrosion.

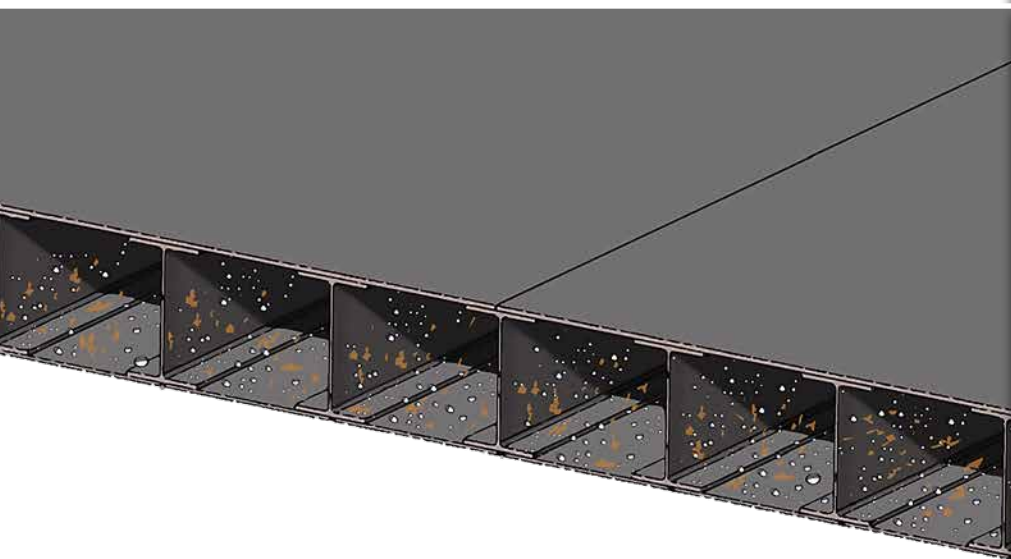

COMPETITOR DISADVANTAGES:

- Unitized steel deck traps condensation which promotes corrosion.
- Improperly-executed weld start and stops and poor weld preparation can cause moisture to penetrate into the deck cavity and create water accumulation and corrosion.

LOAD CELL CABLES

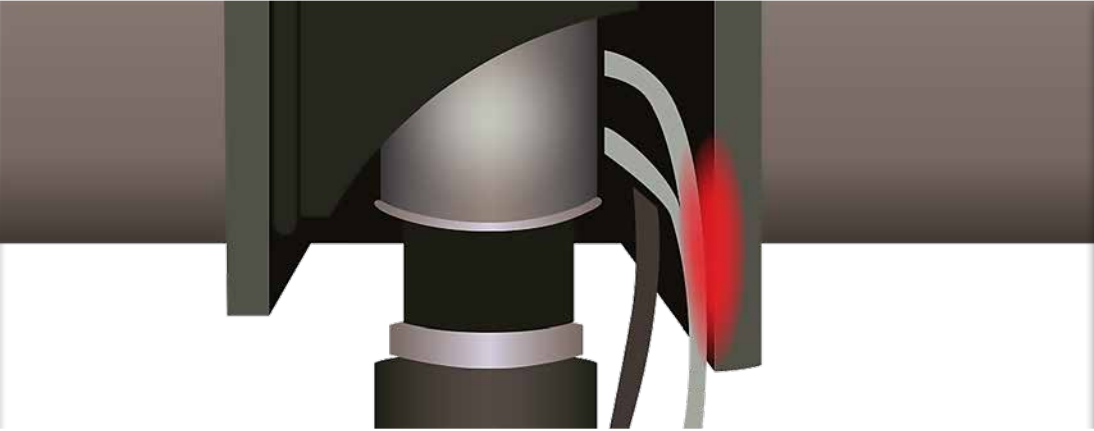

COMPETITOR DISADVANTAGES:

- Wire routing causes wires to rub on the head plate causing wear on the cables and possible premature failure.

ADVANTAGES OF DIGITAL LOAD CELLS

- SmartCell® installation set-up and maintenance is greatly simplified over older analog systems.
- Diagnostics are easy to perform, even for novice technicians new to the scale industry.
- The SmartCell® digital system detects and diagnoses faults and failures more quickly, efficiently, and precisely.
- SmartCell® load cells are daisy-chained together, greatly easing cable runs.
- Simplified wiring system and no junction box eliminates problems associated with traditional analog load cell systems.
- Repair costs are greatly reduced.
- Changing a load cell in the event of a failure is quick and easy (typically takes under 5 minutes).
- Load cell level diagnostics allow for troubleshooting directly through Cardinal indicators.
- Scale productivity is increased due to expedited diagnosis.
- SmartCell® iSite diagnostic software sends cell failure notifications to scale technicians.
- SmartCell® issues can be diagnosed from a remote location.
- SmartCell® stainless steel cell design ensures longer cell life and is IP69K rated against water.
- SmartCell digital cells are built to be more reliable and accurate in changing environments.
- Costs associated with inspections are greatly reduced.
- SmartCell® load cells offer the same industry-leading lightning protection that is featured in Cardinal weight indicators.
- axis® gravity-driven system eliminates issues associated with traditional checking systems.
- The axis® load cell stand and ball can be switched out in a matter of minutes.



iSITE REMOTE MONITORING For SmartCell® Digital Load Cells

- Cloud-Based Remote Monitoring for Digital Load Cells
- Text or E-mail Auto Alerts for Errors and Warning Events
- Free to Authorized Cardinal Scale Dealers
- Secure Online Dealer Access Interface for Scale Diagnosis
- Connect to the Cloud via Ethernet Network or Cellular Modem
- Quickly Identify Problems Before They Interrupt Weighing
- Scans Indicator, Homerun Cable, Load Cells, and Load Cell Cable for Errors
- iSite utilizes the default web browsing port 80 to post data to the cloud database server, so Cardinal indicators do not access any other ports or protocols that would compromise network devices or security.

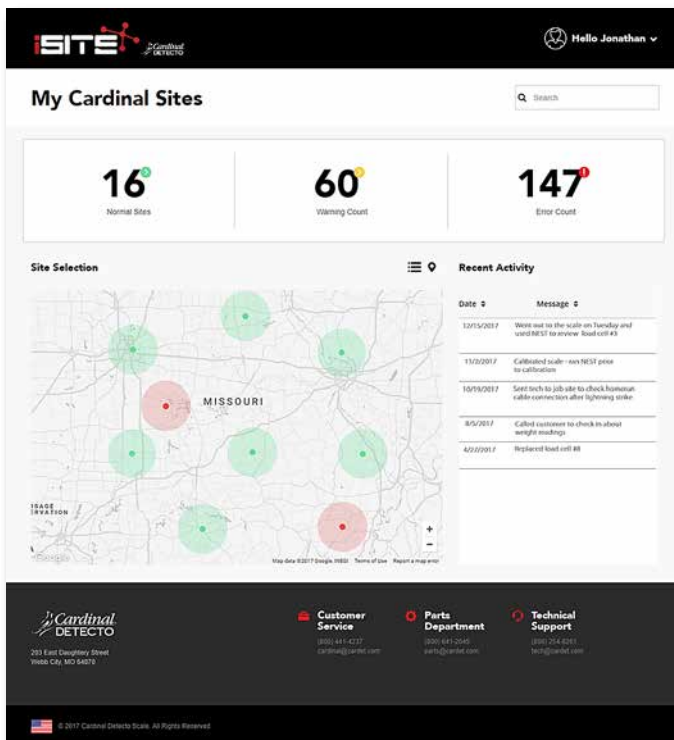

My Cardinal Sites

16^o Normal Sites | 60^o Warning Count | 147^o Error Count

Site Selection

Recent Activity

Date	Message
12/15/2017	Wrote out to the scale on Tuesday and used NEST to review load cell #3
11/2/2017	Calibrated scale - ran NEST prior to calibration
10/19/2017	Sent tech to job site to check homerun cable connections after lightning strike
8/5/2017	Called customer to check in about weight readings
4/23/2017	Replaced load cell #8

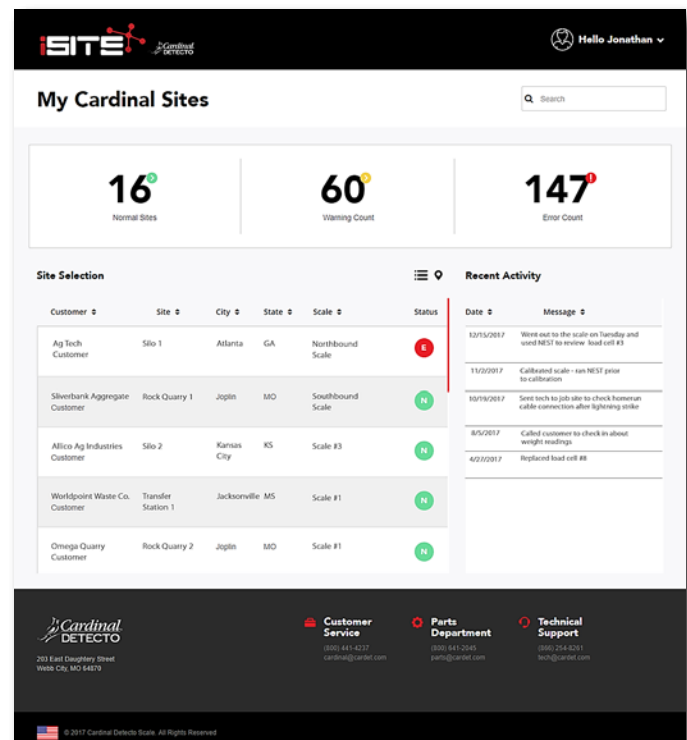

My Cardinal Sites

16^o Normal Sites | 60^o Warning Count | 147^o Error Count

Site Selection

Customer	Site	City	State	Scale	Status
Ag Tech Customer	Silo 1	Atlanta	GA	Northbound Scale	E
Silverbank Aggregate Customer	Rock Quarry 1	Joplin	MO	Southbound Scale	N
Affico Ag Industries Customer	Silo 2	Kansas City	KS	Scale #3	N
Worldpoint Waste Co. Customer	Transfer Station 1	Jacksonville	MS	Scale #1	N
Omega Quarry Customer	Rock Quarry 2	Joplin	MO	Scale #1	N

Recent Activity

Date	Message
12/15/2017	Wrote out to the scale on Tuesday and used NEST to review load cell #3
11/2/2017	Calibrated scale - ran NEST prior to calibration
10/19/2017	Sent tech to job site to check homerun cable connections after lightning strike
8/5/2017	Called customer to check in about weight readings
4/23/2017	Replaced load cell #8

GEOGRAPHIC LOOK-UPS

Once you log into iSite online (isite.cardinalscale.com), you'll have a choice of navigating to your specific digital installations via geographic look-up by map or text-based list view. All of your digital SmartCell® scale installations will be automatically entered into iSite. The maps will automatically indicate any error or warning readings in red. Simply click on the installation site's location to go to a follow-up page for more information.

SITE SELECTION

The iSite home page lets you look up your installations based on a number of different criteria: Customer Name, Purchase Order, Site Name, City, State, Scale Name, etc. Recent Activity is also shown for any technician notes they have entered into iSite or warning readouts.

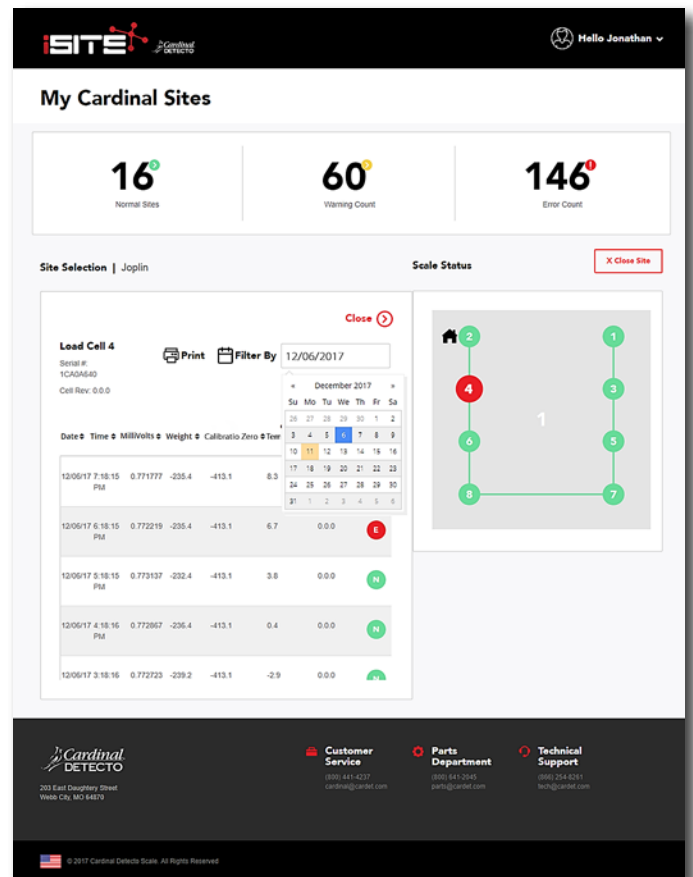
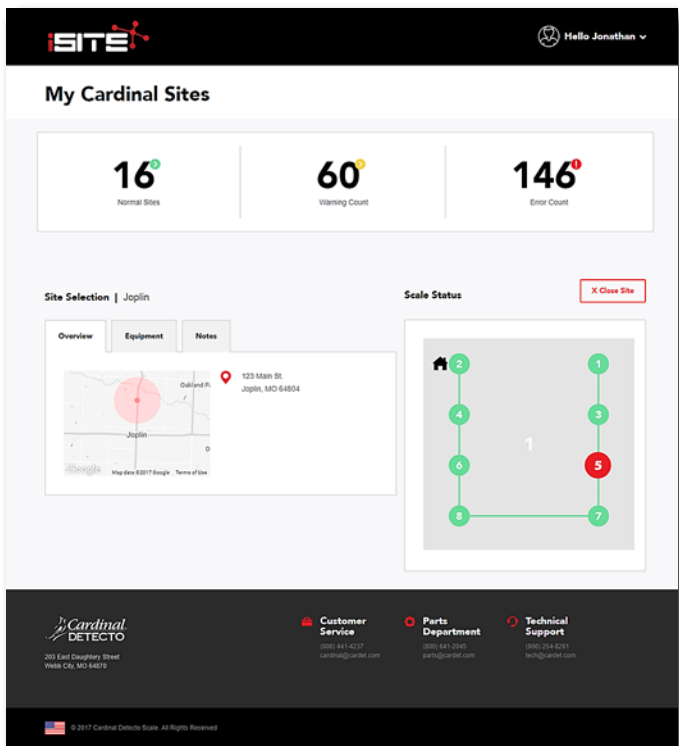

VEHICLE SCALE DIAGRAM

Real-time digital load cell diagnostics identify problems before they cause inaccurate weighing. When you click on a particular site, a scale diagram will be shown with normally-functioning load cells displayed in green and load cells or cables with errors designated in red. The diagram lets you quickly identify where the issue is located within the scale.

SPECIFIC LOAD CELL DATA

If you click on a particular load cell, the following iSite screen will display more detailed load cell diagnostic data, such as date, time, millivolts, weight, calibration, and temperature readings. iSite also provides warnings for home run cable and load cell cable issues.

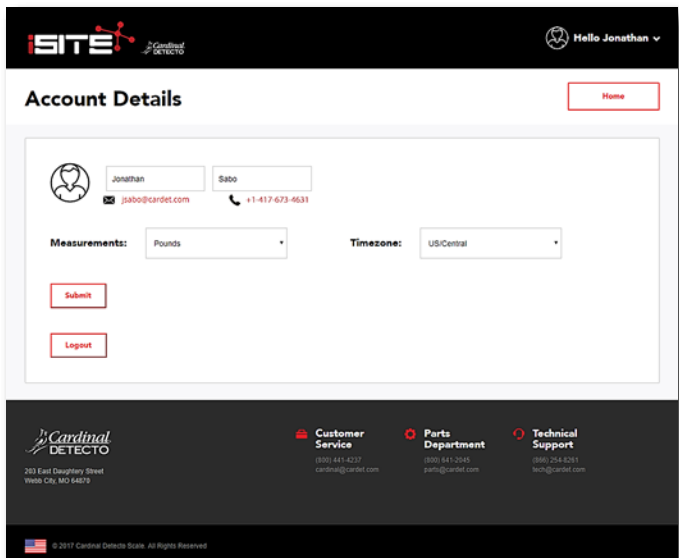

SECURE DATA TRANSMISSIONS:

iSite utilizes the default web port 80 to issue a POST command to push data to an Amazon Web Services database server using the HTTP protocol. This data is posted to the server utilizing the popular JSON format. Additionally, it uses the same port to issue a GET command to receive the mode (Standard or Diagnostic) and frequency in which the indicator posts data. Cardinal Scale indicators do not utilize any other ports or protocols that would compromise network devices and/or security.

ACCOUNT DETAILS

iSite accounts may be set up for any authorized Cardinal Scale dealer personnel. You may select Metric or Imperial for your readouts and the Time Zone for your location. E-mail and/or text contact info may be changed by contacting Cardinal Technical Support or Customer Service.

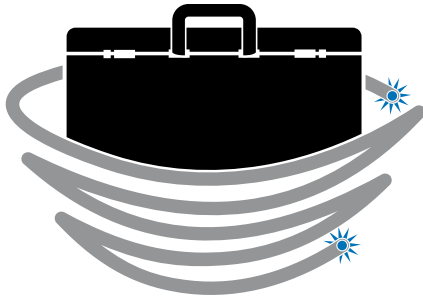

NEST

Network Enabled Scale Tool



NEST All-in-One Scale Diagnostic Toolkit

- Encompasses both digital and analog load cells.
- Diagnostics include digital load cell cables (M12 connectors), including the home run cable.
- Communicates with both ports of digital cells.
- Fast and powerful truck scale diagnostics.
- Wi-Fi standard for connectivity with free NEST mobile app.
- Free mobile app is available for Android® and Apple® devices.
- Helpful for all technician levels from new hires to experienced veterans.
- Quick Start Guide decal inside suitcase.
- Provides home run cable and weight indicator diagnostics.
- USB port to update firmware for digital load cells.
- Battery operated.





FAST AND POWERFUL TRUCK SCALE DIAGNOSTICS

Cardinal Scale's NEST provides fast, accurate, and ultra-portable truck scale diagnostics. Quickly view individual load cell readings and check the home run cable and weight indicator diagnostics. NEST is compatible with both analog and digital cells. This dual functionality extends to diagnosing load cells, home run cables, and load cell cables of both varieties.

Unique to the weighing industry, NEST provides a service technician the toolkit to see where a scale's potential issues may exist within seconds. Utilizing Cardinal's 225 indicator, you can view up to 12 distinct load cell readings onscreen simultaneously, which allows you to quickly and easily scan for anomalies that need further investigation. NEST allows you to view the diagnostics in your choice of millivolts or pounds. There are three display modes: signals display, minimum-maximum display, and signals minus zero reference display.

Operating on rechargeable battery power for easy portability, there are just four simple questions during NEST's lightning-fast set-up. It will default at start-up to assume the load cells have a rated capacity of 75,000 pounds and a rated output of 2 mV/V.

The beneficial functionality of NEST may be retrofit to any competitor's truck scale by replacing the existing junction box with a Cardinal section seal trim box, or the circuit board itself on older Cardinal trim boxes.

NEST TOOLKIT INCLUDES:

- Outdoor-grade, rugged black carrying case
- 225NEST indicator with rechargeable battery
- 2 digital load cell cables
- Four cable connectors to home run cable, weight indicator, and load cells 1-6 and 7-12
- Wi-Fi antenna
- AC power cable to recharge battery
- Megohmmeter

TIPPING THE SCALES



CARDINAL SCALE'S ARMOR® TRUCK SCALE INCREASES BENEFITS FOR VEHICLE WEIGHING

With high truck volume, scale inaccuracy and downtime can result in tens or hundreds of thousands of dollars in profit loss every year. Many facilities have long lines, creating an increased need for a robust, consistent vehicle scale providing minimum downtime and maximum output. Waste facilities generate increased chances for scale malfunctions due to waste contamination and build-up combined with potentially challenging environmental scenarios. Performing inspections can be timely and very costly when diagnosing and correcting mechanical and wiring malfunctions. Cardinal Scale's ARMOR® series truck scales provide answers to these distinct issues.

The design advantages start with the weighbridge. The ARMOR® steel deck now integrates internal I-beam structural upgrades. The weighbridge employs 12-inch-high, 4-inch-wide I-beams supporting the deck. Four rows of welded stiffeners provide additional rigidity and safeguards against I-beam deflection. These advancements now boast the highest CLC in the truck scale industry—50 tons concentrated load capacity!

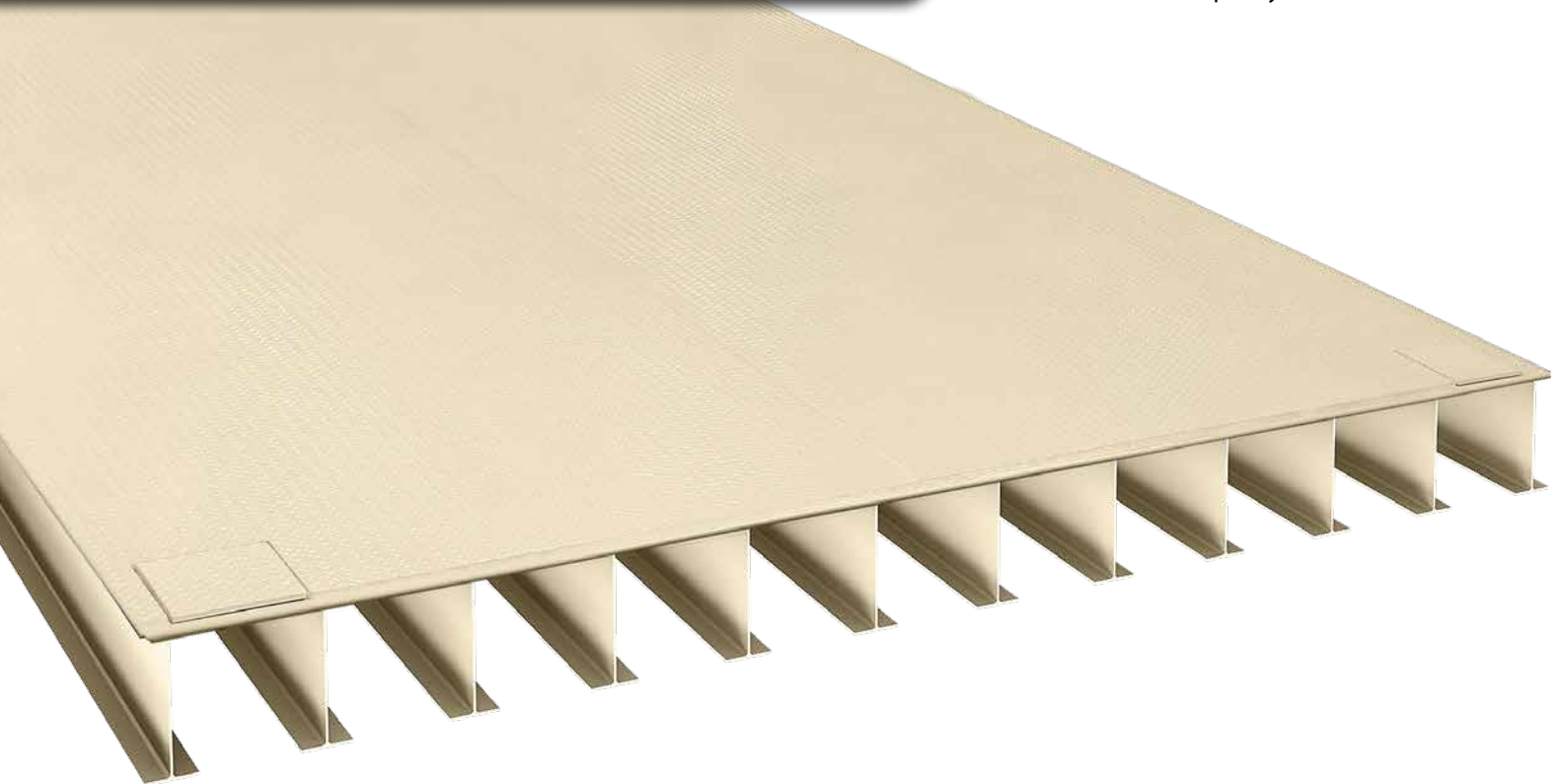

TIPPING THE SCALES

CARDINAL SCALE'S ARMOR® TRUCK SCALE INCREASES BENEFITS FOR VEHICLE WEIGHING

ARMOR® truck scales are built to accept an average daily traffic volume of up to 250 vehicles per day, 365 days per year, for 20 years, assuming that 100% of the vehicles are fully loaded with the equivalent of 80,000 pounds on their dual tandem axle. Those numbers testify that ARMOR® truck scales are built to last a lifetime of weighing use.

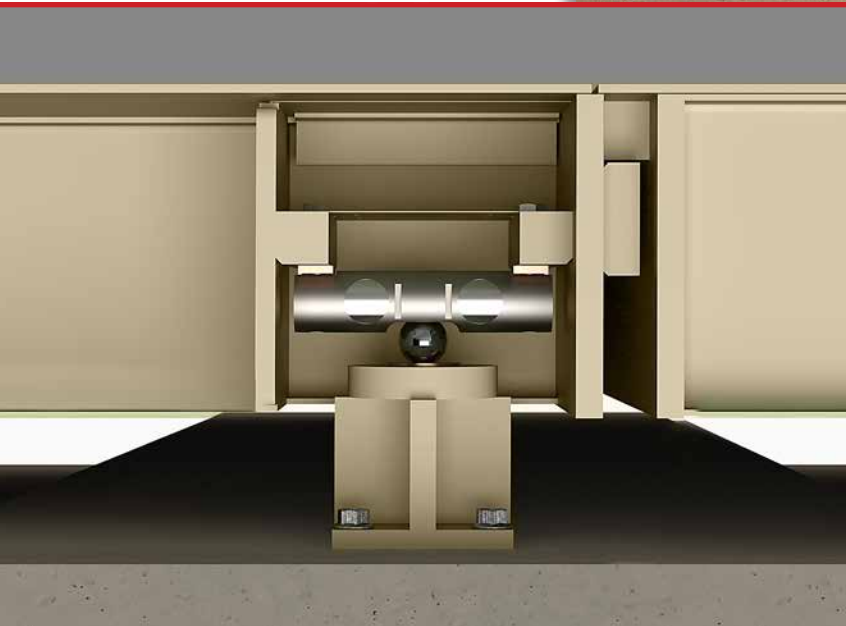

Cardinal Scale's advanced SmartCell® digital load cell system eliminates junction boxes and does not require AC power running to the scale. Messy, time-consuming wiring is no longer necessary. The simple cell-to-cable design directly links load cells to one another, providing a user-friendly system that is much easier to maintain and manage. In the unlikely event of a load cell failure, the connectors on the cables make service a very quick affair to swap out load cells. In addition, Cardinal Scale's SmartCell® load cells are mounted near the top of the scale, further removing the exposure to debris and moisture that is prevalent in the solid waste industry. SmartCell® metal braided cables are rodent-proof, giving an extra layer of protection. Exclusively from Cardinal Scale, the axis® load cell stands employ a unique ball and cup system that uses gravity for load centering which eliminates the need for checkrods and bumper bolts.

225 NAVIGATOR

Cardinal Scale's 225 Navigator indicator can store up to 200 ID's, with the added bonus of storing 200 temporary ID's. Amongst the many items displayed are truck descriptions, material prompts, and tare weights. One-inch high characters are easy to view under any lighting condition. When used with digital truck scales, the 225 indicator has the added benefit of storing calibration on the digital load cell card which allows for ease of recalibration in the event of a component failure. Changing a load cell should require no adjustments to calibration.



TIPPING THE SCALES

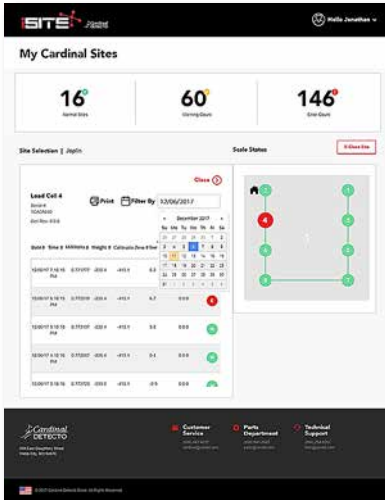

In addition to all of the aforementioned benefits, the ARMOR® truck scale is also available with Guardian® hydraulic load cells that are 100% impervious to water and lightning, two of the most common issues to plague sanitation industry truck scales. Guardian® hydraulic load cells come with a lifetime load cell warranty when used in ARMOR® truck scales. The end result is maximum up-time when the customer considers factors like weather, power surge issues at the site, and water damage, protecting a long-term investment for maximum gain in operations.

CARDINAL SCALE'S ARMOR® TRUCK SCALE INCREASES BENEFITS FOR VEHICLE WEIGHING

Another innovation from Cardinal Scale is the Cloud-based iSite remote monitoring system. This intuitive diagnostics system can be monitored from any location in the world via an online control panel. Any alerts produced by the SmartCell® digital load cells are sent via text or email, sharply reducing time-consuming diagnoses. Once a scale technician receives an alert, they can log into an online control panel dashboard to look up further diagnostic details. Peak performance can be more easily achieved due to expedited information flow and early error detection. Explanatory prompts give technicians helpful tips on where to start when diagnosing an issue. This makes it easy to diagnose a truck scale issue, even for novice technicians.



These combined attributes create great advantages for recycling and solid waste facilities when choosing Cardinal Scale. The ARMOR® truck scale with either SmartCell® digital load cells or Guardian® hydraulic load cells is NTEP and Measurement Canada legal for trade. Less time is spent replacing component parts, diagnosing load cell issues, and dealing with weighbridge structural problems. The cumulative time saved is a great return on investment for the customer and a great savings in service fees. Truly, Cardinal Scale has reinvented the steel deck and advanced scale technology into the next generation.

DIGITAL LOAD CELLS CABLE CHART

SMART CELL[®]

DIGITAL LOAD CELLS

Ft of 18ga Homerun Cable	NUMBER OF LOAD CELLS IN SCALE																
	4	6	8	10	12	14	16	18	20	22	24	26	28	30	32	34	36
100	12 V	12 V	12 V	12 V	12 V	12 V	15 V	15 V	15 V	24 V	24 V	24 V	24 V	24 V	24 V	24 V	24 V
200	12 V	12 V	12 V	12 V	12 V	15 V	15 V	15 V	15 V	24 V	24 V	24 V	24 V	24 V	24 V	24 V	24 V
300	12 V	12 V	12 V	12 V	15 V	15 V	15 V	15 V	24 V	24 V	24 V	24 V	24 V	24 V	24 V	24 V	24 V
400	12 V	12 V	12 V	12 V	15 V	15 V	15 V	15 V	24 V	24 V	24 V	24 V	24 V	24 V	24 V	24 V	24 V
500	12 V	12 V	12 V	15 V	15 V	15 V	15 V	24 V	24 V	24 V	24 V	24 V	24 V	24 V	24 V	24 V	24 V
600	12 V	12 V	12 V	15 V	15 V	15 V	24 V	24 V	24 V	24 V	24 V	24 V	24 V	24 V	24 V	24 V	24 V
700	12 V	12 V	12 V	15 V	15 V	15 V	24 V	24 V	24 V	24 V	24 V	24 V	24 V	24 V	24 V	24 V	24 V
800	12 V	12 V	15 V	15 V	15 V	15 V	24 V	24 V	24 V	24 V	24 V	24 V	24 V	24 V	24 V	24 V	24 V
900	12 V	12 V	15 V	15 V	15 V	24 V	24 V	24 V	24 V	24 V	24 V	24 V	24 V	24 V	24 V	24 V	24 V
1000	12 V	12 V	15 V	15 V	15 V	24 V	24 V	24 V	24 V	24 V	24 V	24 V	24 V	24 V	24 V	24 V	24 V
1100	12 V	12 V	15 V	15 V	24 V	24 V	24 V	24 V	24 V	24 V	24 V	24 V	24 V	24 V	24 V	24 V	24 V
1200	12 V	15 V	15 V	15 V	24 V	24 V	24 V	24 V	24 V	24 V	24 V	24 V	24 V	24 V	24 V	24 V	24 V
1300	12 V	15 V	15 V	15 V	24 V	24 V	24 V	24 V	24 V	24 V	24 V	24 V	24 V	24 V	24 V	24 V	24 V
1400	12 V	15 V	15 V	15 V	24 V	24 V	24 V	24 V	24 V	24 V	24 V	24 V	24 V	24 V	24 V	24 V	24 V
1500	12 V	15 V	15 V	24 V	24 V	24 V	24 V	24 V	24 V	24 V	24 V	24 V	24 V	24 V	24 V	24 V	24 V
1600	12 V	15 V	15 V	24 V	24 V	24 V	24 V	24 V	24 V	24 V	24 V	24 V	24 V	24 V	24 V	24 V	24 V
1700	12 V	15 V	15 V	24 V	24 V	24 V	24 V	24 V	24 V	24 V	24 V	24 V	24 V	24 V	24 V	24 V	24 V
1800	12 V	15 V	15 V	24 V	24 V	24 V	24 V	24 V	24 V	24 V	24 V	24 V	24 V	24 V	24 V	24 V	24 V

Ft of Cable in Scale	69	123	177	231	285	339	393	447	501	555	609	663	717	771	825	879	933
-------------------------	----	-----	-----	-----	-----	-----	-----	-----	-----	-----	-----	-----	-----	-----	-----	-----	-----

OPTIONS (POWER REQUIRED AT THE SCALE):

- Media box with AC power
- Glass Fiber (1 mile)
- Plastic Fiber (300 ft)
- SnapStream wireless (1 mile unobstructed line of sight – repeaters available)

KEY

12 V — 825

15 V — 225

24 V — Power at Scale

CUSTOMER SERVICE:

PH: 1-800-441-4237
 FAX: 417-673-2153
 E-MAIL: cardinal@cardet.com

PARTS DEPARTMENT:

PH: 1-800-641-2045
 E-MAIL: parts@cardet.com

TECH SUPPORT:

PH: 1-866-254-8261
 E-MAIL: tech@cardet.com



Cardinal Scale reserves the right to improve, enhance, or modify features and specifications without prior notice.